

Since 1994

Nurmag Plastik

**Aluminium Insulation and
System Profiles Catalogue**

Alüminyum Isı Yalıtım ve
Sistem Profilleri Katalođu



Nurmag Plastik

*SOME PROFILES IN OUR CATALOGUE ARE FOR VISUAL PURPOSES ONLY.
SALES WILL NOT BE MADE TO A SECOND COMPANY OUTSIDE OF THE FIRMS WITH WHICH A CONTRACT HAS BEEN ESTABLISHED.
OUR COMPANY CANNOT BE HELD RESPONSIBLE FOR TYPOGRAPHICAL ERRORS.*

*KATALOĞUMUZDAKİ BAZI PROFİLLER ÖZEL PROFİL OLUP SADECE GÖRSEL AMAÇLIDIR.
SÖZLEŞME YAPILAN FİRMALAR DIŞINDA İKİNCİ BİR FİRMAYA SATIŞ YAPILMAZ.
TİPOGRAFİK HATALARDAN FİRMAMIZ SORUMLU TUTULAMAZ*

CONTENTS

İÇİNDEKİLER



POLYAMIDE THERMAL BREAKERS
POLIAMIT ISI BARIYERLER

05



PVC THERMAL BREAKERS
PVC ISI BARIYERLER

06



CURTAIN WALL SPACERS
GAGA PROFİLLERİ

09



'U' CHANNEL PROFILES FOR SLIDING SYSTEMS
'U' KANAL PROFİLLERİ

13



BOX PROFILES
KUTU PROFİLLERİ

18



CLAMPING PROFILES
KENET PROFİLLERİ

21



SYSTEM PROFILES
SİSTEM PROFİLLERİ

26

A B O U T U S

Our firm was founded under the name of Nur Plastik Profil in Kartal in 1994. The firm took a prominent place in plastic profile industry by the contributions of its well-informed and experienced staff in a short time period. The company moved to its new-built factory by growing capacity in Kurtköy-İstanbul in 1997.

Our trading title was changed and registered as Nurmag Plastik.San.Tic.Ltd.Şti. in 2008 . Thanks to our great experience we are able to design and produce our own moulds for tailor-made profile demands .Nurmag has reached more than 2000 kinds of plastic extrusion profiles so far.

With the increasing demand of Polyamide (PA66GF25) insulation barriers, we established new Polyamide barrier facilities adjacent to our Pvc Factory in Kurtköy-İstanbul .Thereby ,we expanded our product range by manufacturing of high quality level Polyamide insulation profiles.Our main priority is to achieve the best thermal performances for aluminium doors,windows and façade systems.

It has always been honor to be involved in exclusive architectural systems of leading aluminium companies. Nurmag Plastik has adopted a customer oriented service concept and has gained its customers' appreciations by being committed to on-time delivery services and consistent quality level since 1994 .



HAKKIMIZDA

Firmamız 1994 yılında Nur Plastik Profil adı altında 1 adet pvc ekstrüder ile faaliyetlerine başlamış ve kısa süre içerisinde bünyesinde bulundurduğu ekstrüzyon alanında deneyimli ve uzman personeliyle sektörde hak ettiği yeri almış olup artan talebi karşılamak amacıyla 1997 yılında Pendik-Kurtköyde kendi üretim tesisine taşınmıştır .

Ticari ünvanımız 2008 yılında Nurmag Plastik San.Ti.c.Ltd.Şti olarak tescil ettirilmiştir.

Nurmag Plastik olarak Alüminyum sistemlerinde kullanılan standart profiller ile birlikte Alüminyum kapı, pencere ve dış cephe sistemlerinin gereksinimi olan talebe özel Pvc profil kalıplarını kendi bünyemizdeki kalıphanemizde en hızlı sürede imal ederek 2000 farklı kalıp sayısına ulaştık .

Firmamız artan talep ile birlikte Kurtköyde bulunan PVC tesisimize bitişik konumda Poli amit ısı yalıtım bariyeri tesisi kurmuş ve alüminyum sektörüne yönelik ürün çeşitliliğini bu alanda genişletmiştir.Sektörün standartlarına uygun yüksek kalite Poli amit ısı yalıtım bariyeri üretimimiz ile yurt içi ve yurt dışındaki alüminyum sektörünün önde gelen firmalarının sistemlerinde yer almanın haklı gururunu yaşamaktayız.

Kuruluşumuzdan bu yana müşteri odaklı bir hizmet anlayışı benimsenmiş olup istikrarlı kalite anlayışı ve zamanında teslimat ilkesine verdiğimiz önemle plastik ekstrüzyon alanında alüminyum sektörünün önde gelen çözüm ortağı olmayı sürdürmekteyiz.

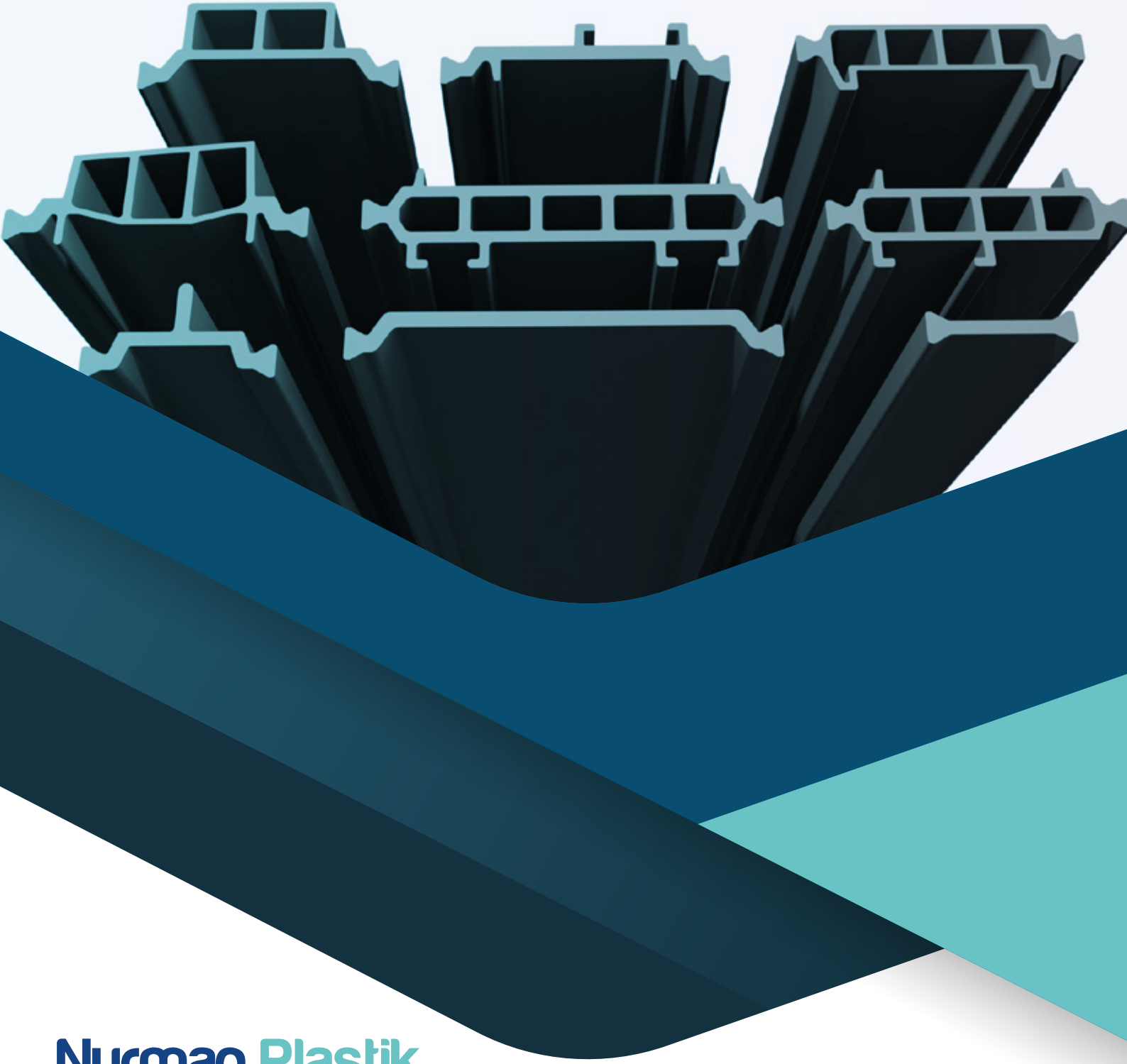

Nurmag Plastik

**POLYAMIDE (PA66GF%25)
THERMAL INSULATION PROFILES**











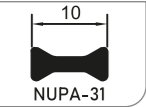
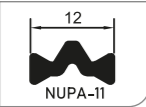
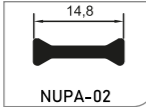
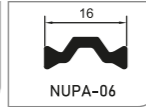
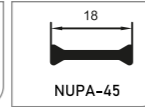
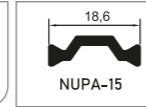
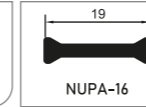
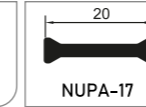
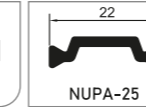
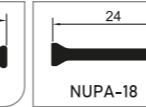
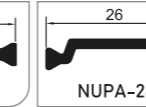
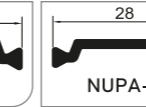

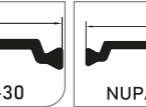
POLIAMIT ISI BARIYER
PROFİLLERİ

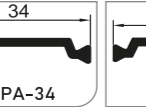
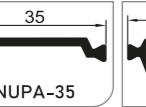
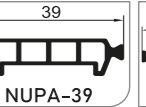
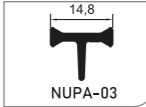
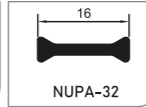
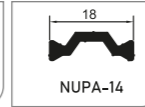
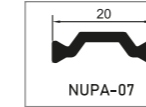
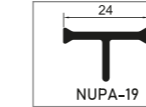
POLYAMIDE (PA66GF%25) THERMAL INSULATION PROFILES

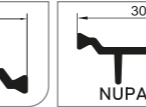
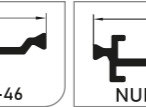
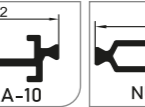
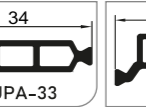
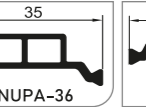
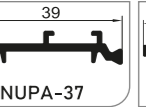
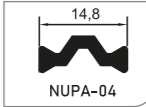
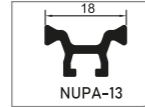
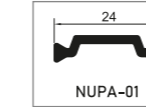
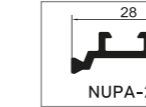
POLIAMIT ISI BARIYER PROFİLLERİ

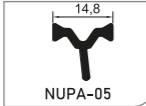
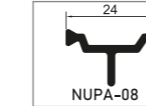
POLYAMIDE EXTRUSION

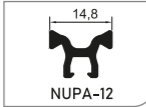
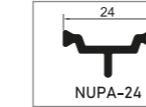
(PA66GF%25)

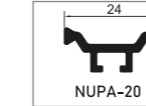

10 mm	12 mm	14,8 mm	16 mm	18 mm	18,6 mm	19 mm	20 mm	22 mm	24 mm	26 mm	28 mm	30 mm	32 mm	34 mm	35 mm	39 mm	54 mm
 NUPA-31	 NUPA-11	 NUPA-02	 NUPA-06	 NUPA-45	 NUPA-15	 NUPA-16	 NUPA-17	 NUPA-25	 NUPA-18	 NUPA-26	 NUPA-28	 NUPA-30	 NUPA-09	 NUPA-34	 NUPA-35	 NUPA-39	 NUPA-54
	 NUPA-03	 NUPA-32	 NUPA-14				 NUPA-07		 NUPA-19		 NUPA-27	 NUPA-46	 NUPA-10	 NUPA-33	 NUPA-36	 NUPA-37	 NUPA-41
		 NUPA-04		 NUPA-13					 NUPA-01		 NUPA-29			 NUPA-21		 NUPA-38	
		 NUPA-05							 NUPA-08					 NUPA-22		 NUPA-40	
		 NUPA-12							 NUPA-24					 NUPA-23			
									 NUPA-20								

THERMAL BREAKERS

PVC THERMAL BREAKERS

PVC ISI BARIYER PROFİLLERİ

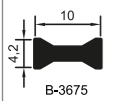
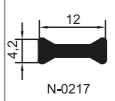
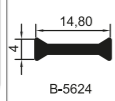
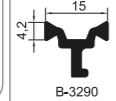
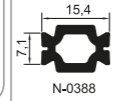
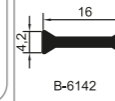
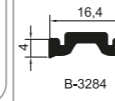
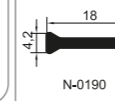
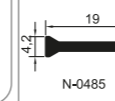
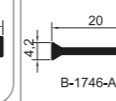
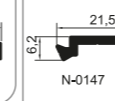
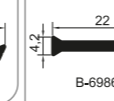
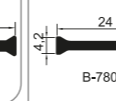
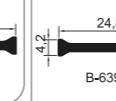
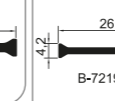
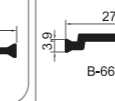
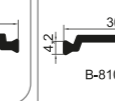
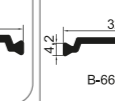
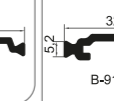
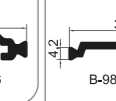
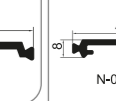
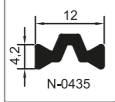
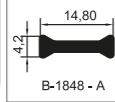
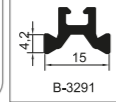
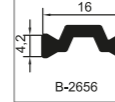
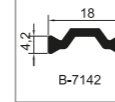
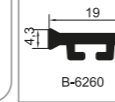
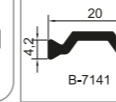
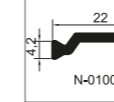
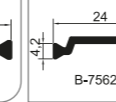
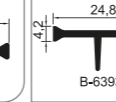
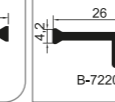
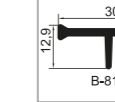
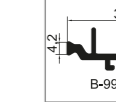
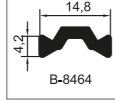
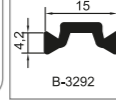
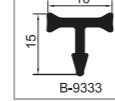
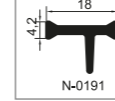
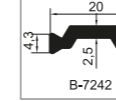
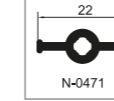
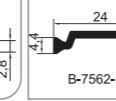
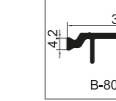
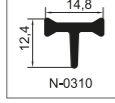
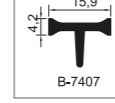
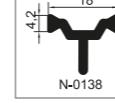
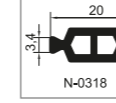
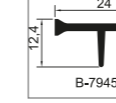
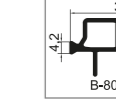
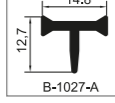
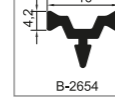
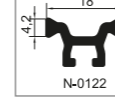
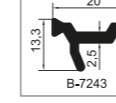
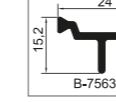
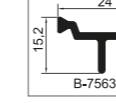
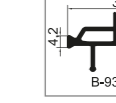
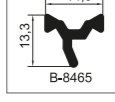
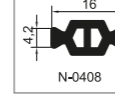
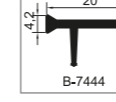
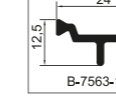
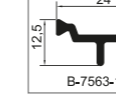
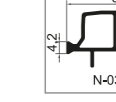
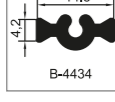
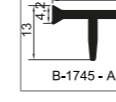
PVC EXTRUSION

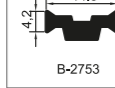
10 mm	12 mm	14,8 mm	15 mm	15,4 mm	16 mm	16,4 mm	18 mm	19 mm	20 mm	21,5 mm	22 mm	24 mm	24,8 mm	26 mm	27,2 mm	30 mm	32 mm	32,5 mm	34 mm	43,3 mm
 B-3675	 N-0217	 B-5624	 B-3290	 N-0388	 B-6142	 B-3284	 N-0190	 N-0485	 B-1746-A	 N-0147	 B-6986	 B-7804	 B-6394	 B-7219	 B-6654	 B-8101	 B-6663	 B-9176	 B-9842	 N-0237
 N-0435	 B-1848 - A	 B-3291		 B-2656		 B-7142	 B-6260	 B-7141		 N-0100	 B-7562	 B-6393	 B-7220		 B-8100				 B-9966	
	 B-8464	 B-3292		 B-9333		 N-0191		 B-7242		 N-0471	 B-7562-1								 B-8023	
	 N-0310			 B-7407		 N-0138		 N-0318			 B-7945								 B-8022	
	 B-1027-A			 B-2654		 N-0122		 B-7243			 B-7563		 B-7563						 B-9344	
	 B-8465			 N-0408				 B-7444			 B-7563-1		 B-7563-1						 N-0387	
	 B-4434							 B-1745 - A			 N-0053									
	 B-2753																			

THERMAL BREAKERS

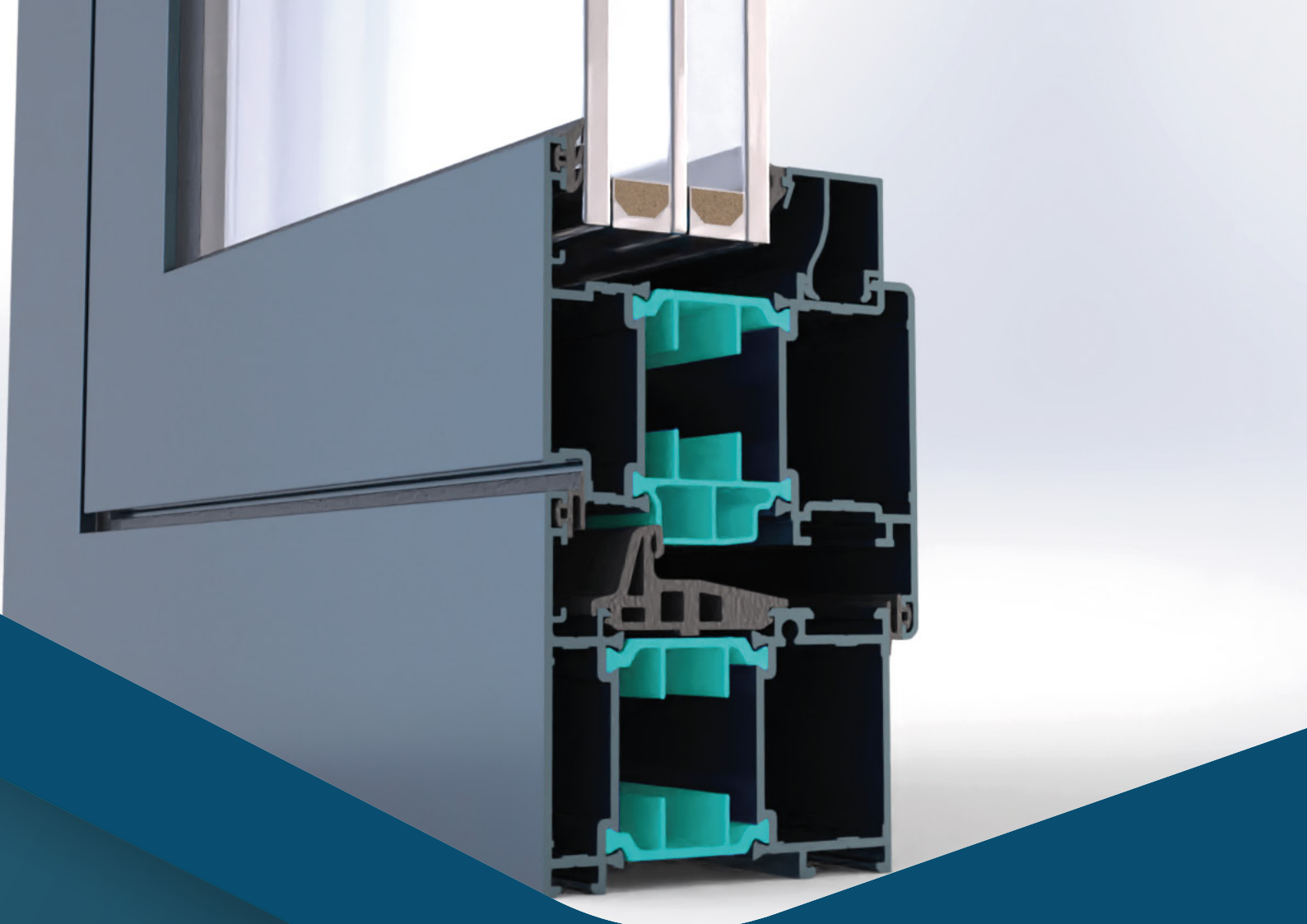

Nurmag Plastik

**PVC THERMAL
BREAKERS**

PVC ISI BARIYER
PROFİLLERİ

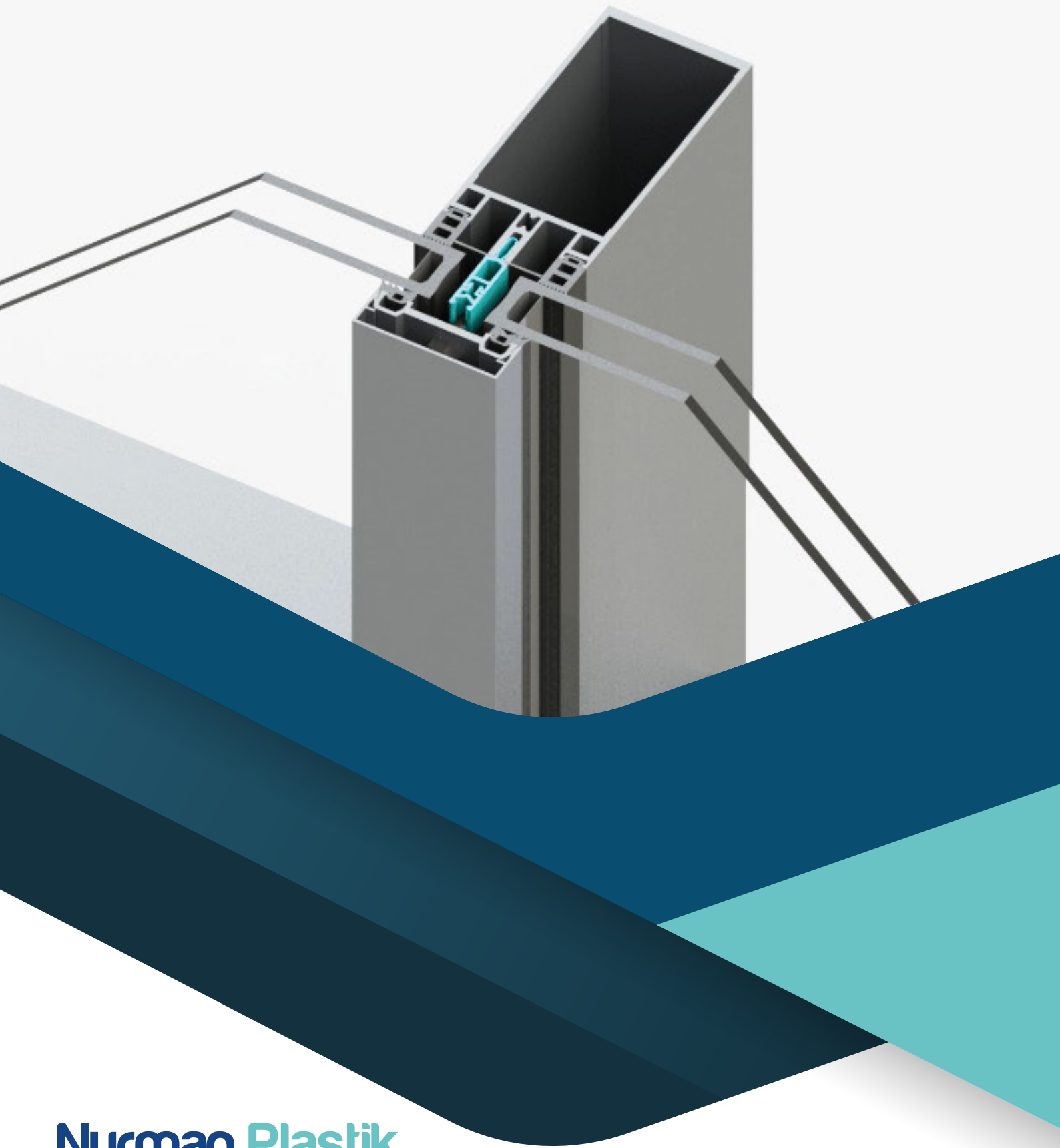

Nurmag Plastik

**CURTAIN WALL
SPACERS**

GAGA
PROFİLLERİ

CURTAIN WALL SPACERS GAGA PROFİLLERİ

B-6902

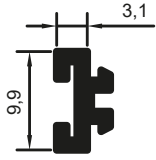

B-6913

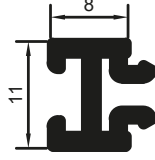

N-0106

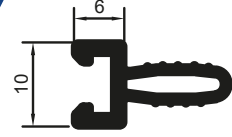

N-0425

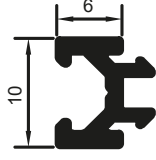

N-0059

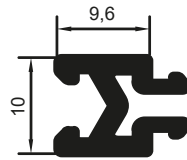

N-0349

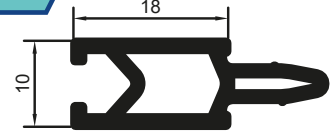

B-7193

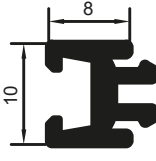

B-9964

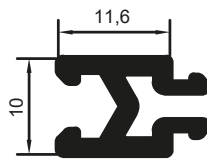

N-0486

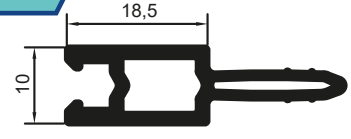

B-7192

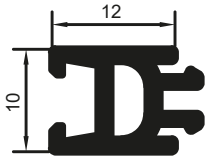

N-0413

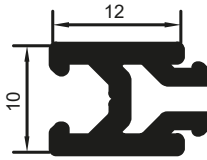

B-9965

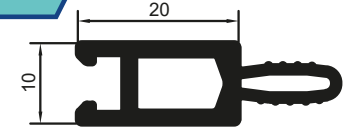

B-7191

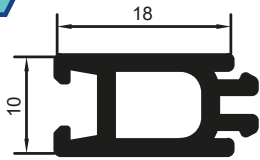

N-0235

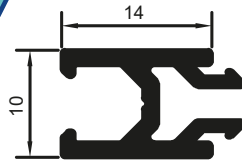

N-0350

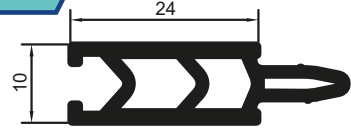

B-9691

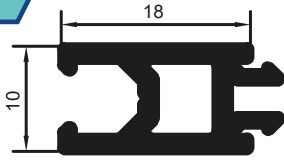

N-0414

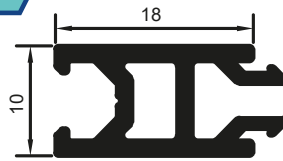

B-9113

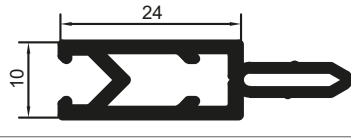

B-7190

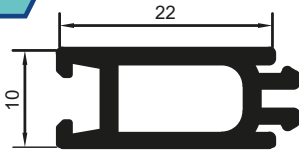

N-0346

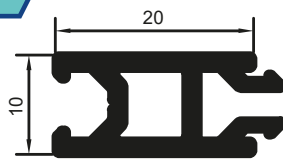

B-7545

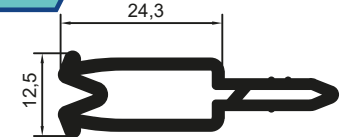

B-9692

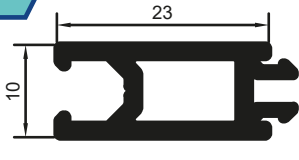

N-0464

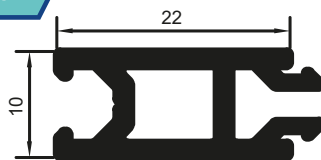

N-0058

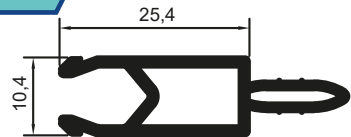

N-0351

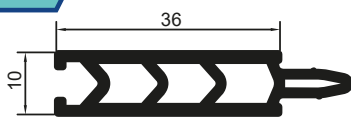

CURTAIN WALL SPACERS GAGA PROFİLLERİ

B-9153

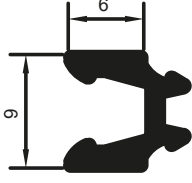

B-6451

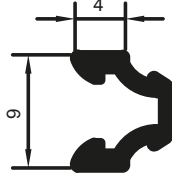

B-6451

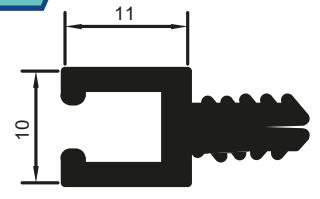

B-9154

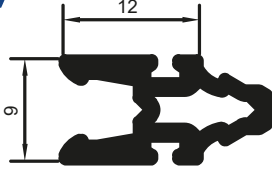

B-5984

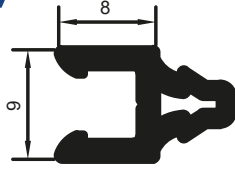

B-4942

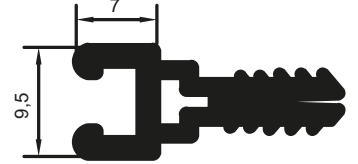

B-9155

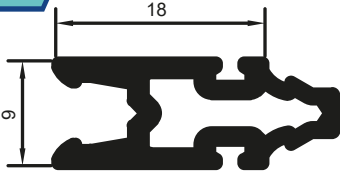

B-6821

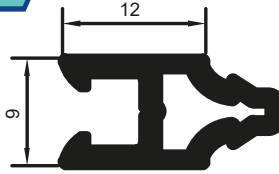

B-4642

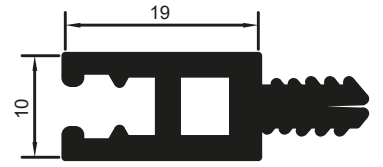

B-9287

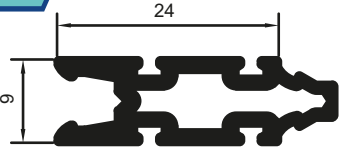

B-6336

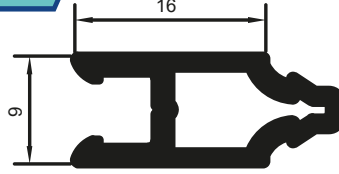

B-8813

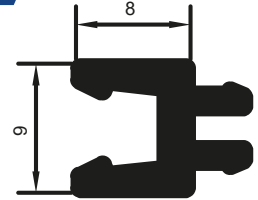

B-8503

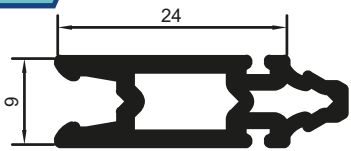

B-8529

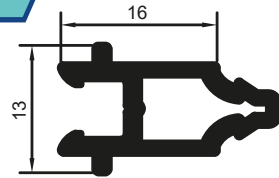

N-0367

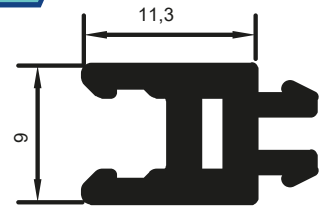

B-6918

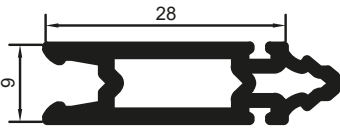

B-5983

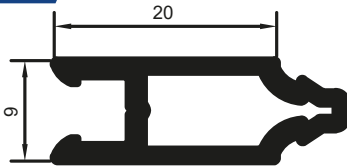

N-0105

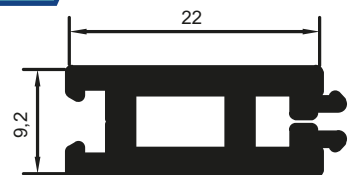

B-9291

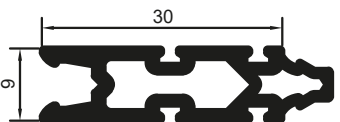

B-8636

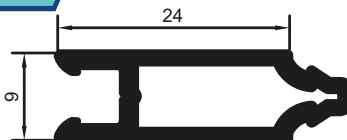

CURTAIN WALL SPACERS GAGA PROFİLLERİ

B-9405

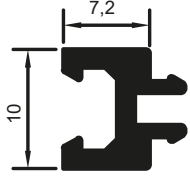

B-6219

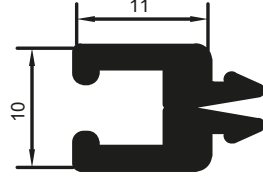

B-8743

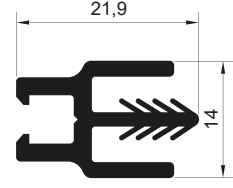

B-9529

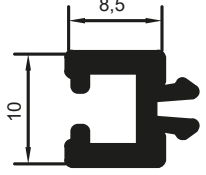

B-6220

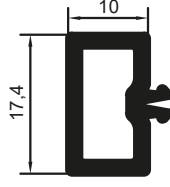

N-0129

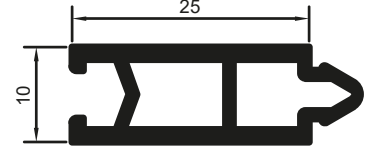

B-9263

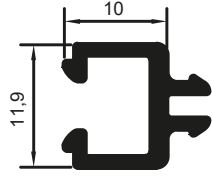

N-0347

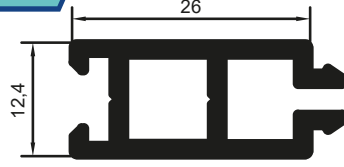

B-9530

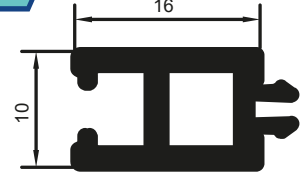

B-9413

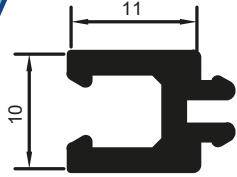

N-0412

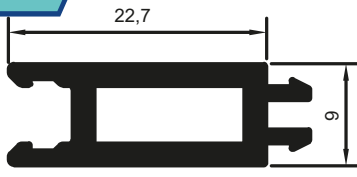

N-0363

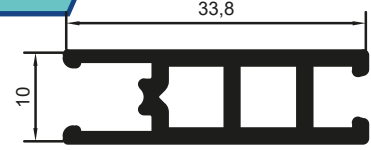

B-2895

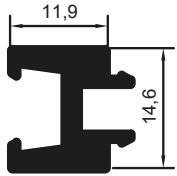

B-1316

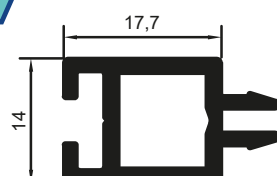

N-0360

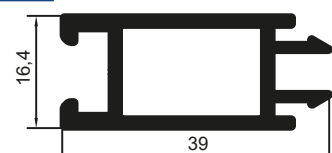

N-0343

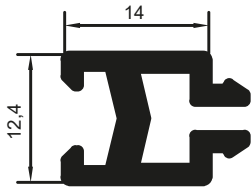

N-0378

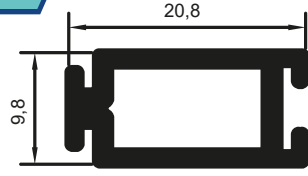

N-0229

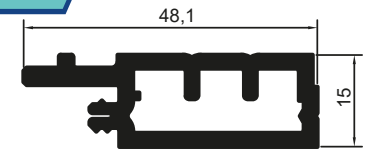

N-0469

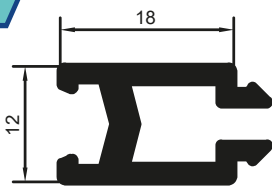

B-4631

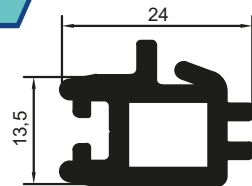

N-0238

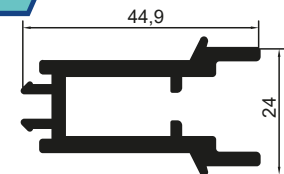

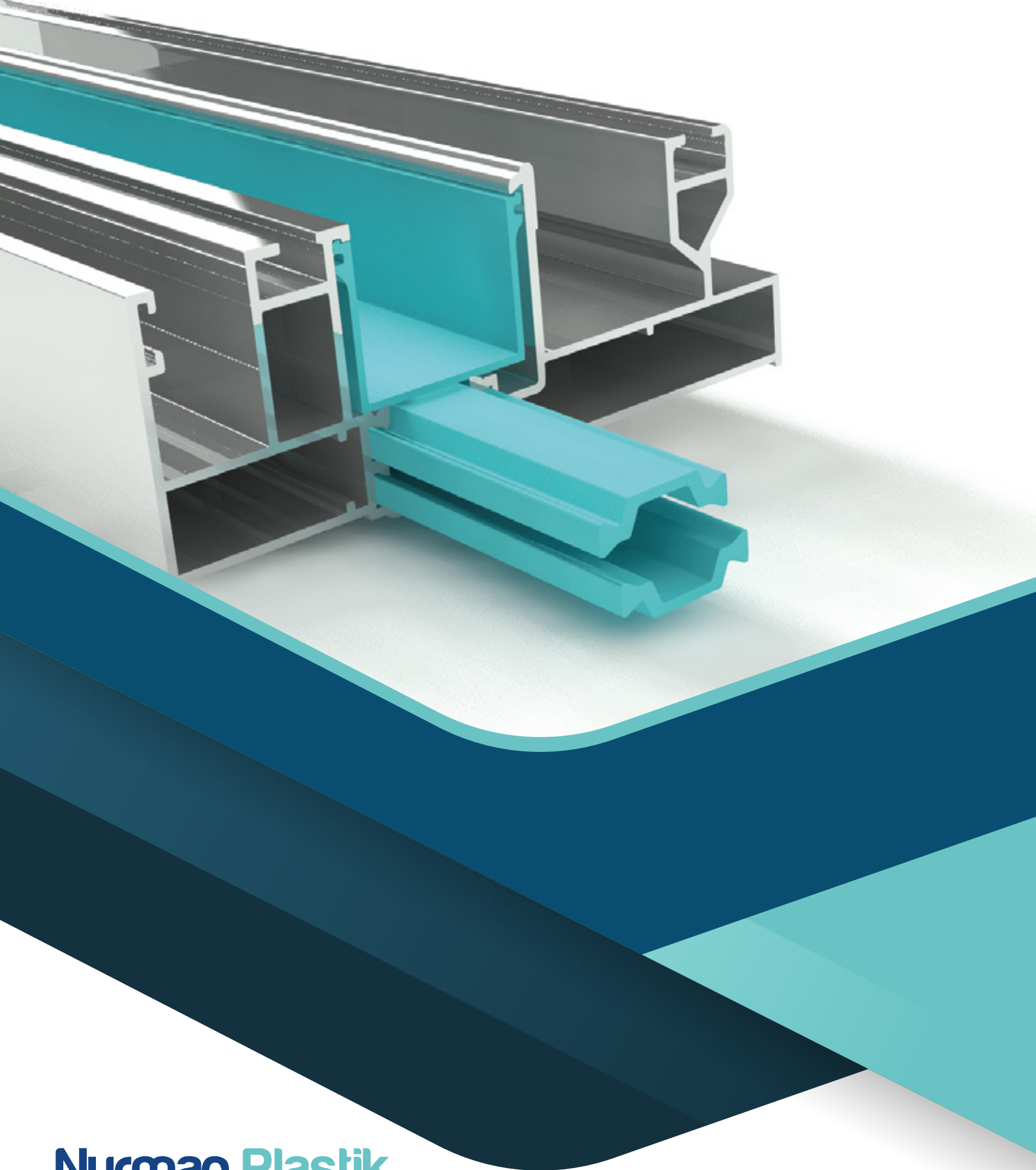

Nurmag Plastik

'U' CHANNEL PROFILES FOR SLIDING SYSTEMS

ALÜMİNYUM SÜRME SİSTEMLER İÇİN
'U' PROFİLLERİ

'U' CHANNEL PROFILES FOR SLIDING SYSTEMS

'U' KANAL PROFİLLERİ

B-8501

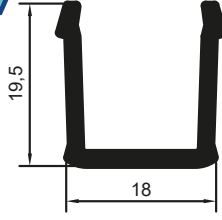

N-0312

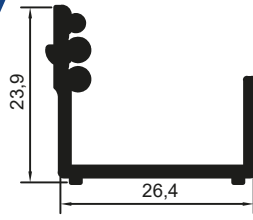

N-0449

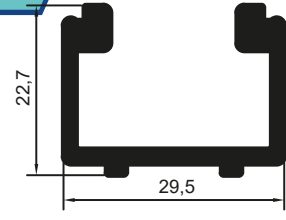

N-0390

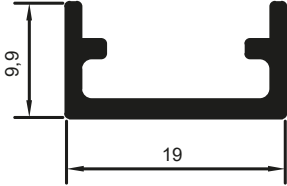

N-0295

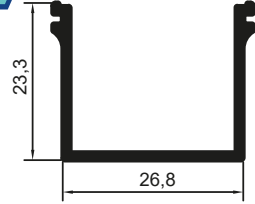

N-0300

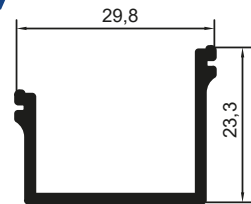

N-0084

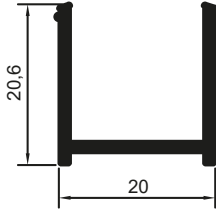

B-8373

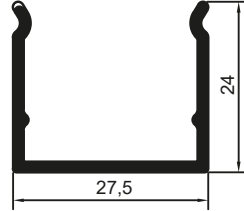

B-8068

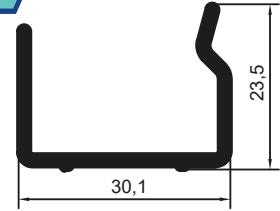

B-5348

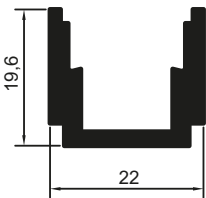

N-0167

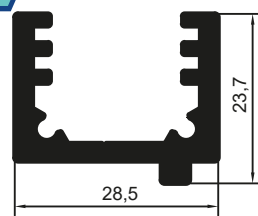

N-0172

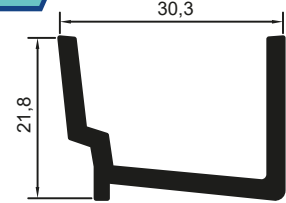

B-4060

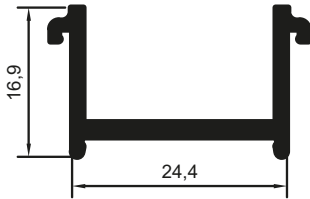

N-0031

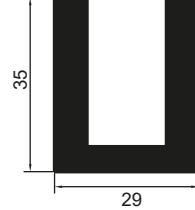

N-0389

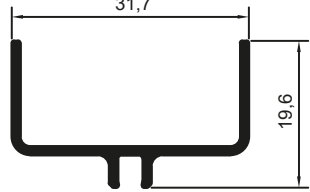

N-0188

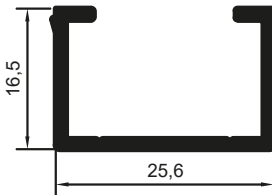

N-0048

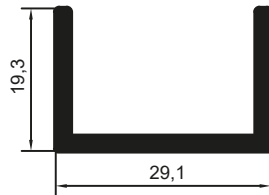

N-0096

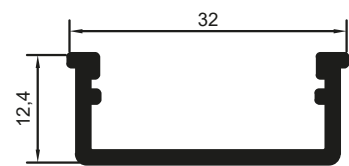

'U' CHANNEL PROFILES FOR SLIDING SYSTEMS 'U' KANAL PROFİLLERİ

N-0274

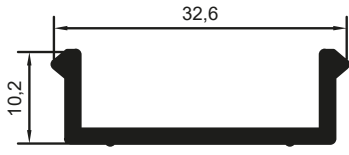

N-0220

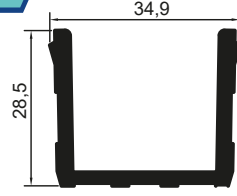

B-4435

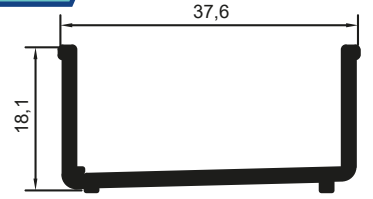

N-0325

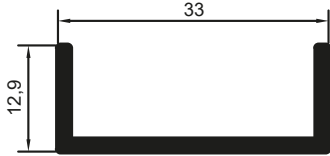

N-0165

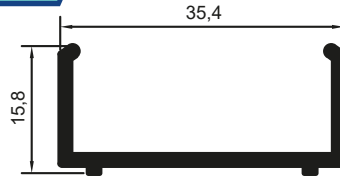

B-8208

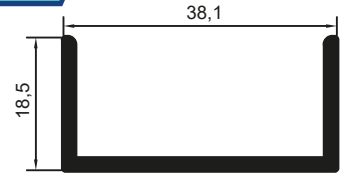

N-0381

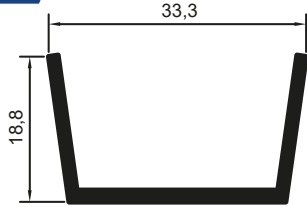

B-7295

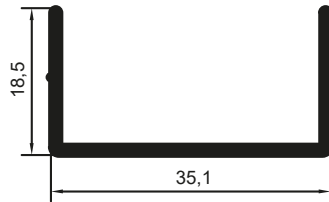

B-8803

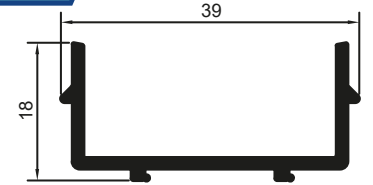

B-3325

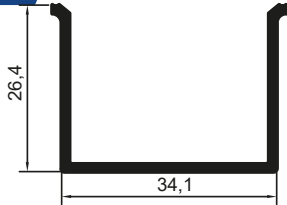

N-0329

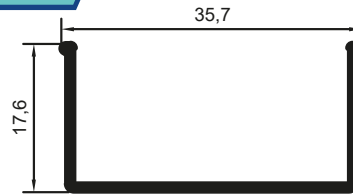

B-7395

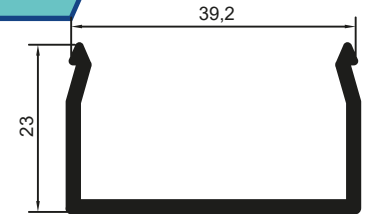

B-5499

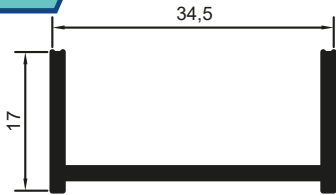

B-9728

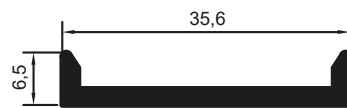

N-0255

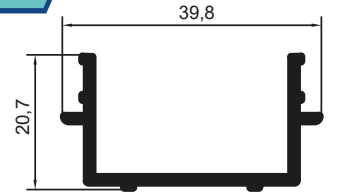

B-5255

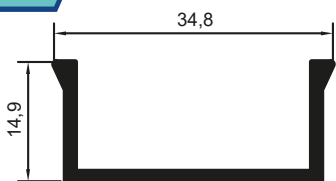

B-4061

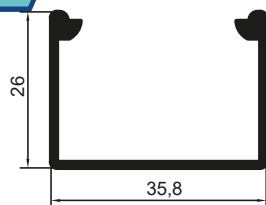

N-0299

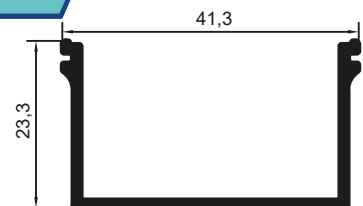

'U' CHANNEL PROFILES FOR SLIDING SYSTEMS

'U' KANAL PROFİLLERİ

B-8352

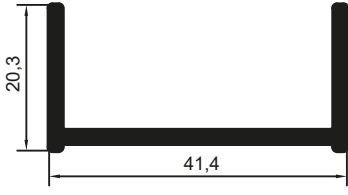

N-0312

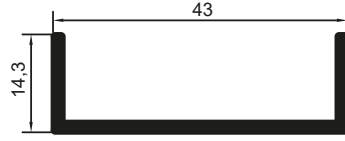

B6909-A

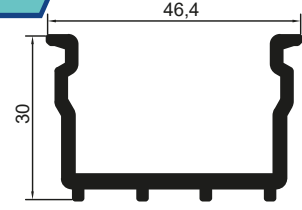

B-7065

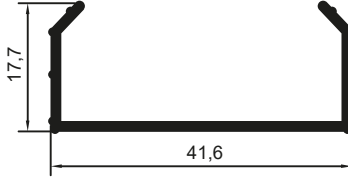

N-0450

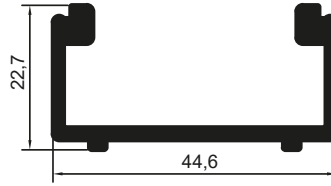

B6909-B

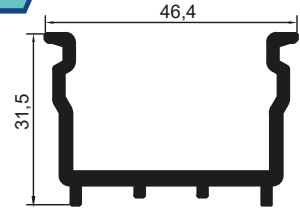

B-7146

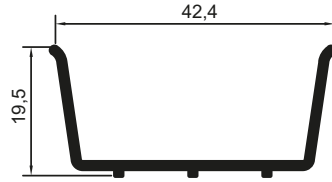

B-9114

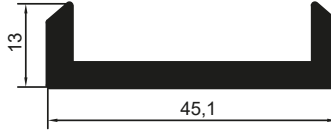

B-7781

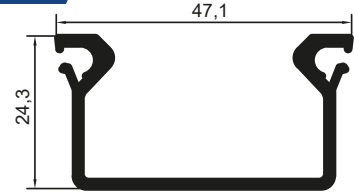

N-0433

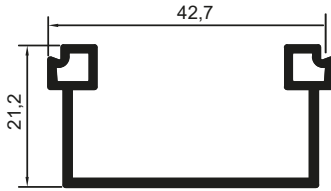

B-8438



B-9636

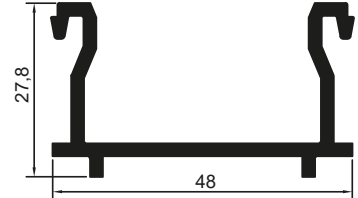

B-4098

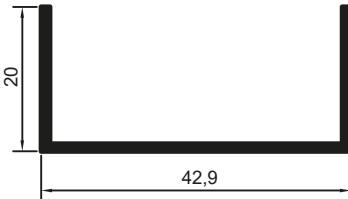

B-9576

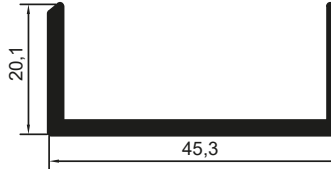

N-0157

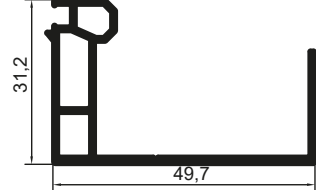

N-0144

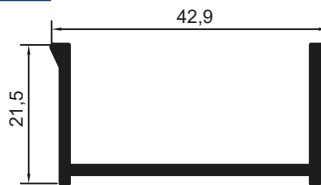

B-2983

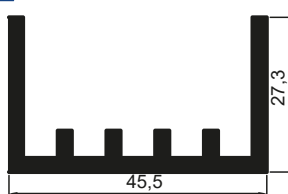

N-0281

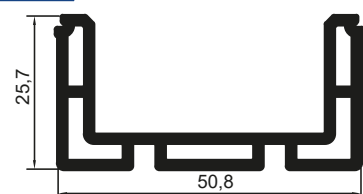

'U' CHANNEL PROFILES FOR SLIDING SYSTEMS

'U' KANAL PROFİLLERİ

N-0023



N-0220

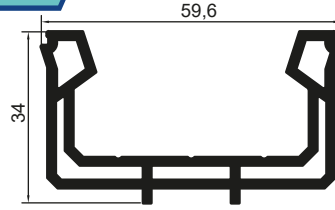

N-0457

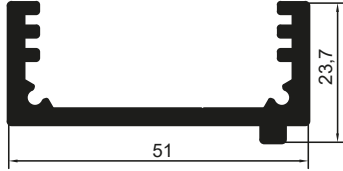

N-0490

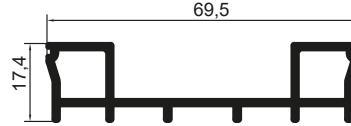

B-6100

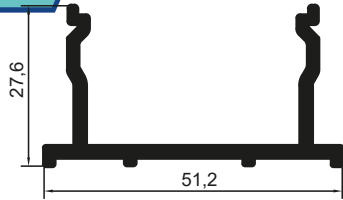

N-0493

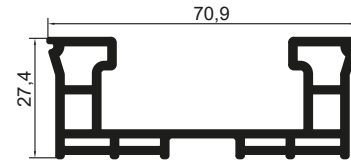

N-0073

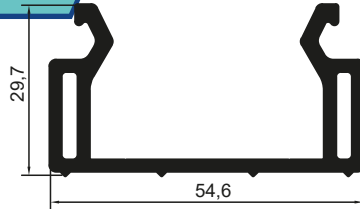

N-0315

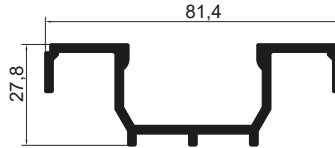

N-0263

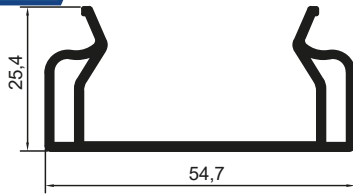

N-0020



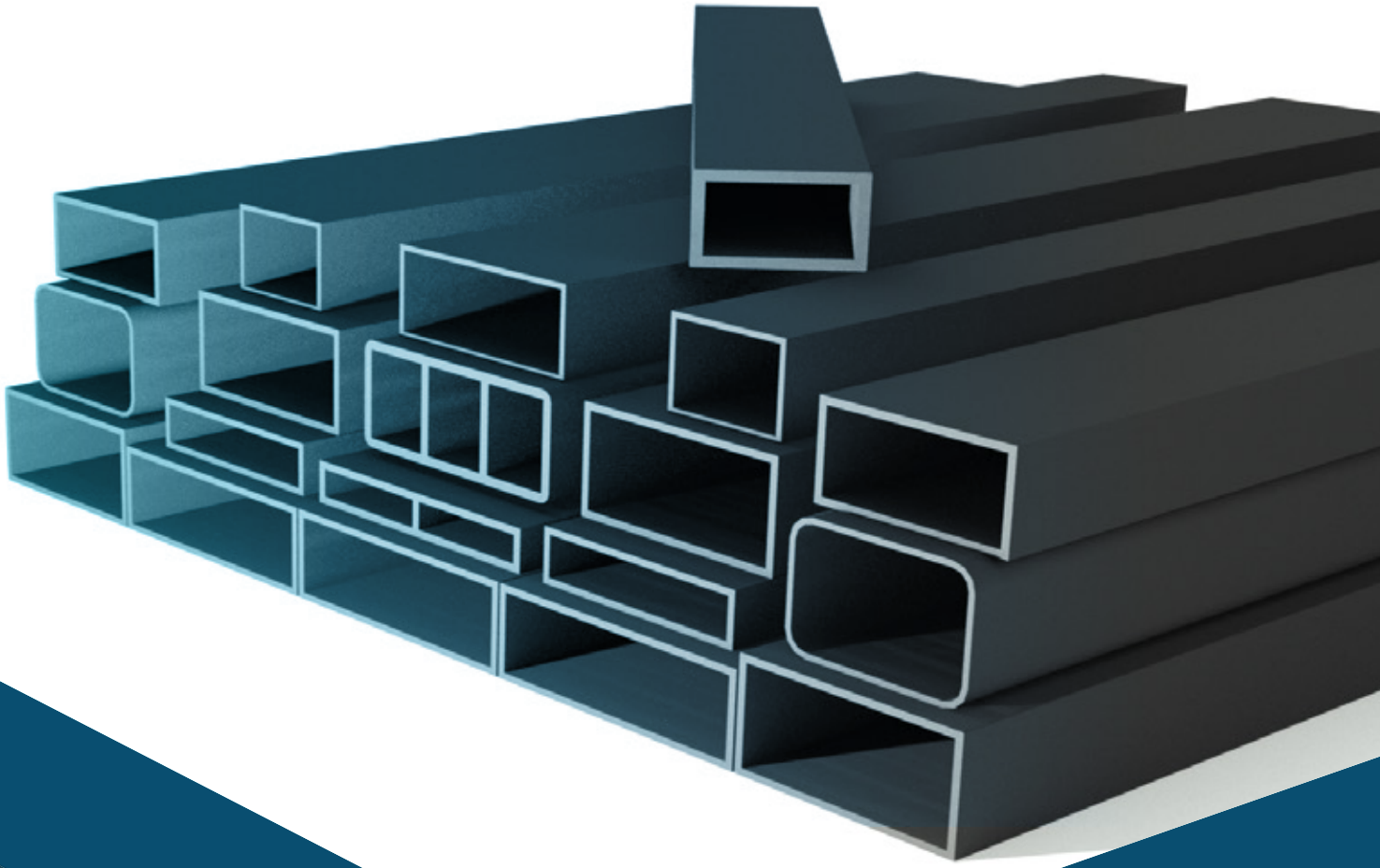

Nurmag Plastik

**BOX
PROFILES**

KUTU PROFİLLERİ

N-0311

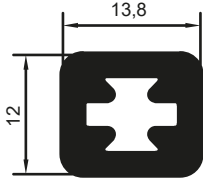

B-5010

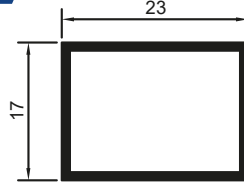

B-5030

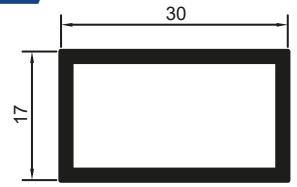

B-8586

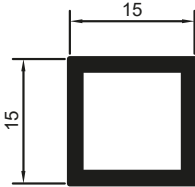

B-5032

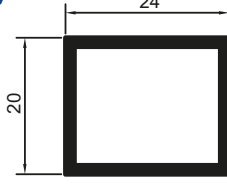

B-7472

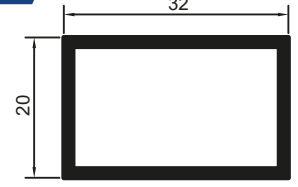

N-0146

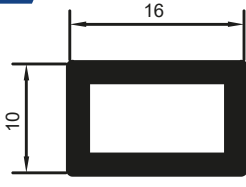

B-5029

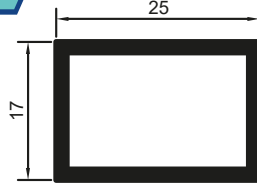

N-0179

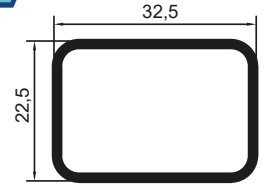

B-4849

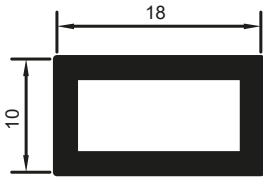

B-7200

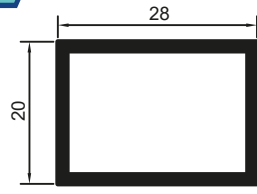

B-5031

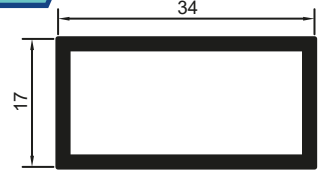

B-6194

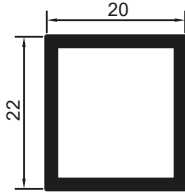

N-0371

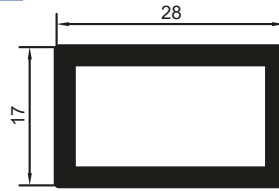

B-5339

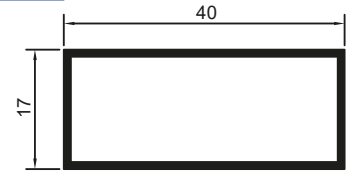

B-9282

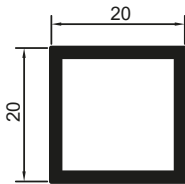

N-0423

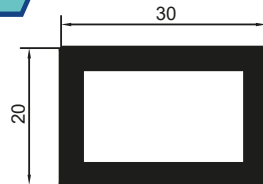

N-0151

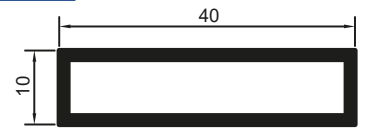

B-2011

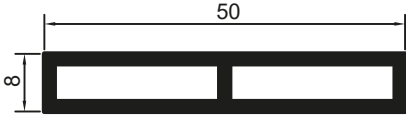

N-0260

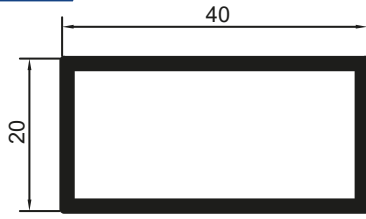

B-9712

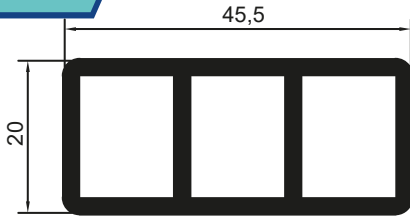

B-9446

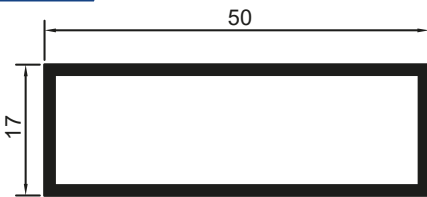

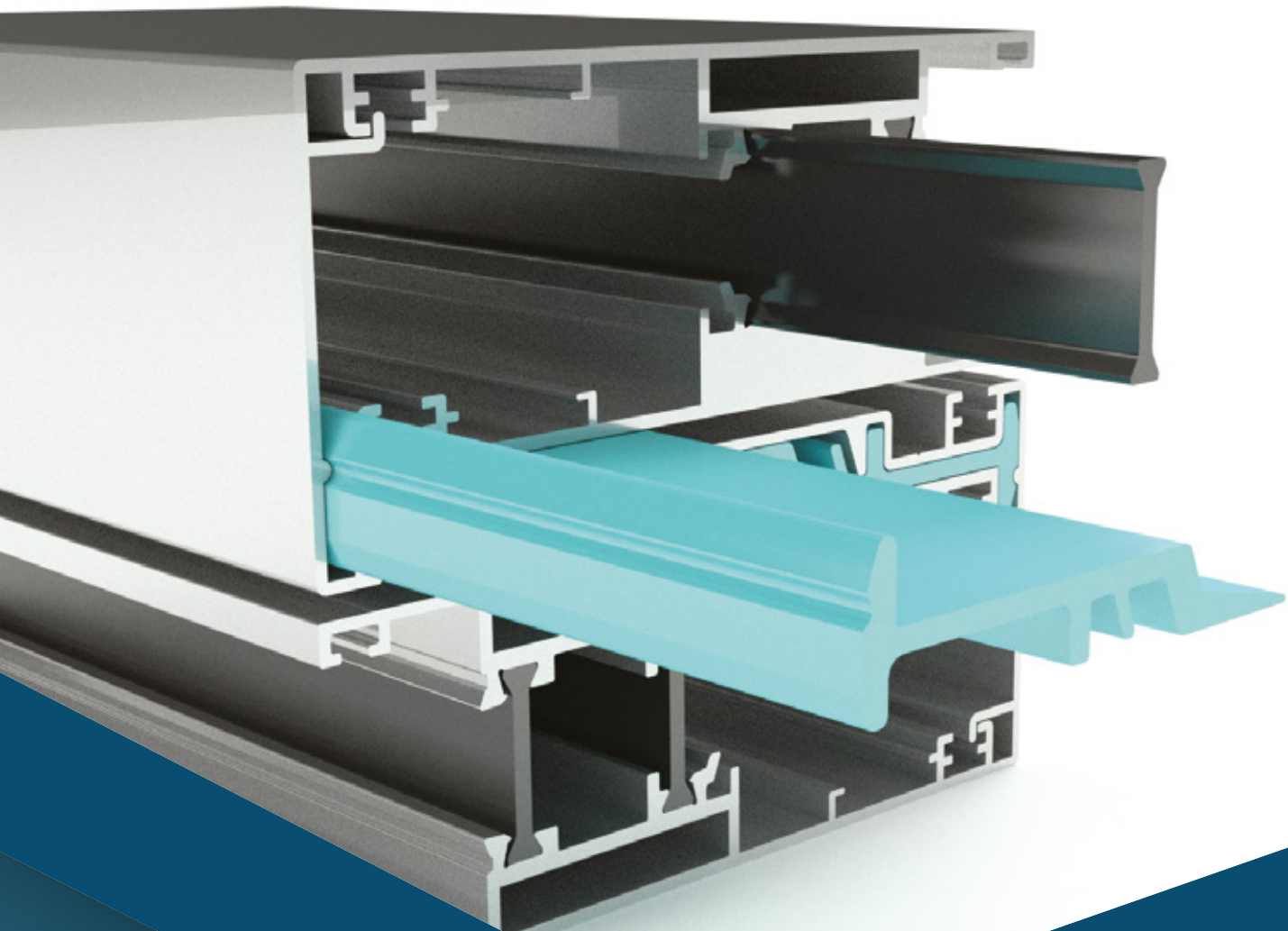

Nurmag Plastik

**CLAMPING
PROFILES**

KENET PROFİLLERİ

CLAMPING PROFILES

KENET PROFİLLERİ

B-6946

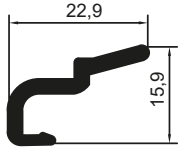

B-7294

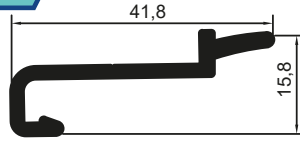

N-0271

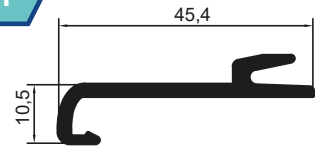

N-0269

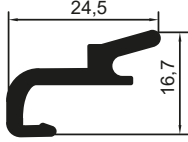

B-6891

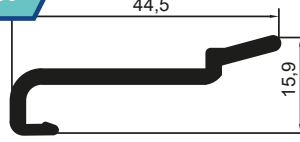

B-9147



B-7385

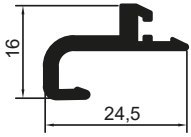

N-0193

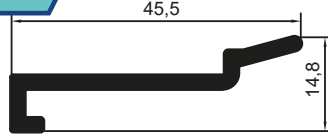

B-7946

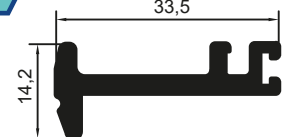

N-0384

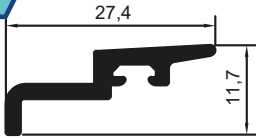

B-8802

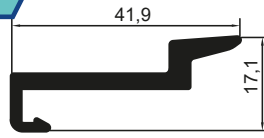

B-8771

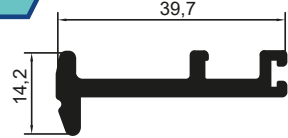

N-0477

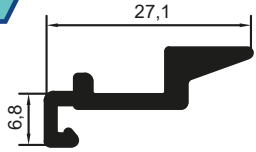

B-8354

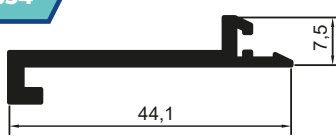

N-0064

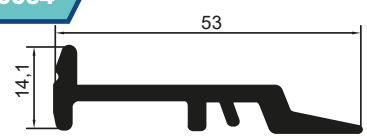

N-0225

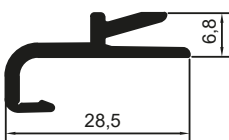

B-8209

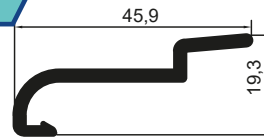

N-0383

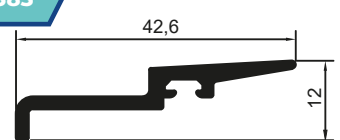

B-7386

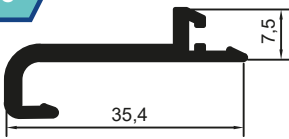

N-0287

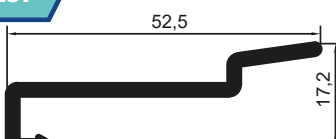

N-0441

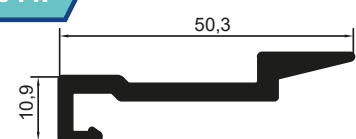

B-5256

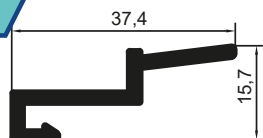

B-9727



N-0171

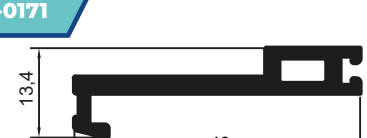

B-3326

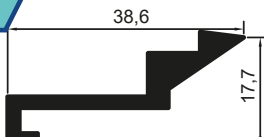

N-0396

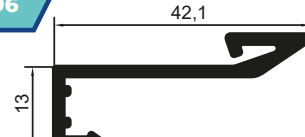

B-8510

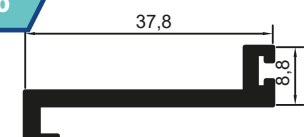

CLAMPING PROFILES

KENET PROFİLLERİ

N-0324

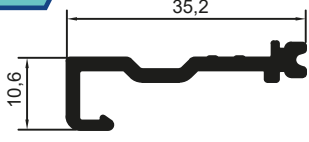

N-0397

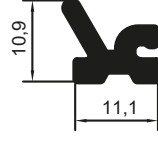

N-0072

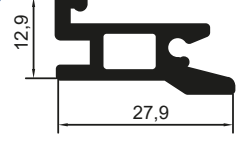

B-7628

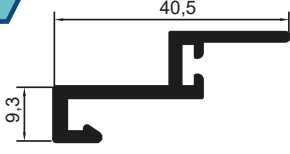

N-0133

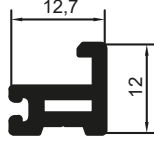

N-0250

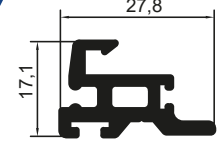

N-0356

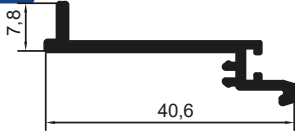

N-0332

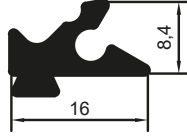

N-0399



B-8124

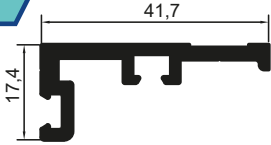

N-0398

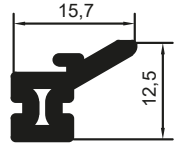

N-0406

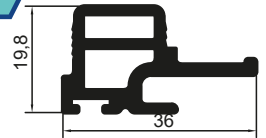

N-0033

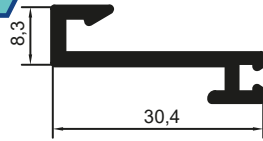

N-0330

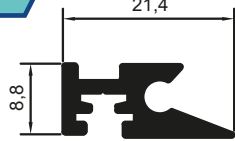

N-0293

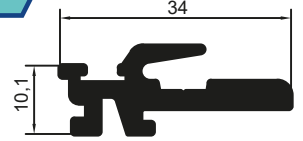

N-0021

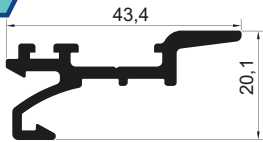

B-8804

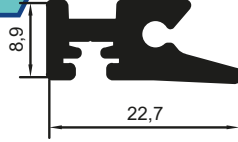

B-4458

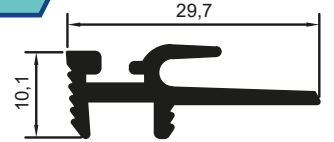

N-0256

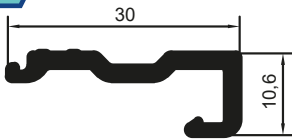

N-0270

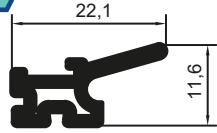

N-0366



N-0257



N-0339

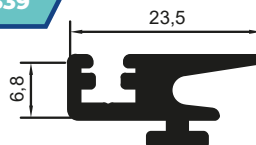

N-0400

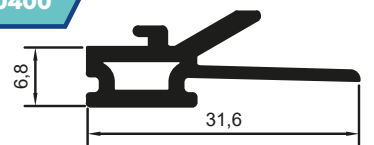

N-0149

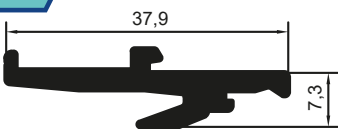

N-0313

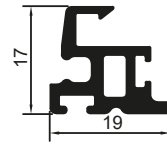

N-0483

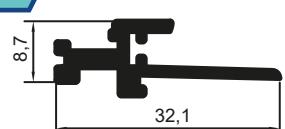

CLAMPING PROFILES

KENET PROFİLLERİ

N-0278

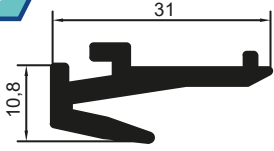

N-0277



N-0286

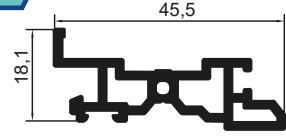

N-0305

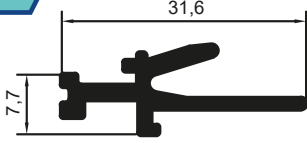

N-0217

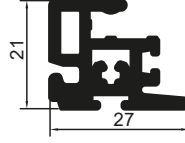

N-0185

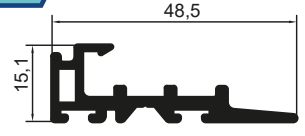

N-0298

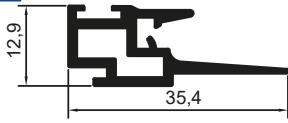

N-0159

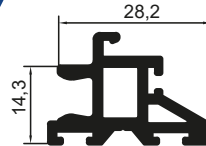

N-0218

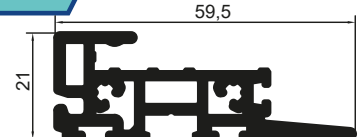

N-0436



N-0456

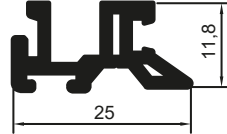

N-0317

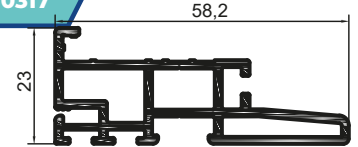

B-9422

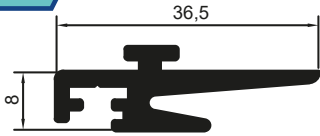

N-0476

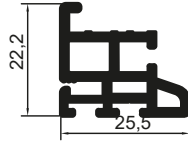

N-0431

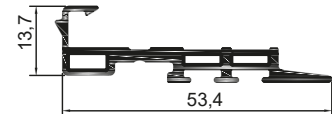

B-8668



N-0475

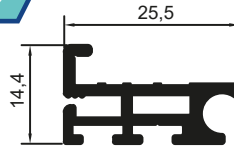

N-0404

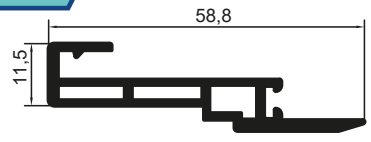

N-0468

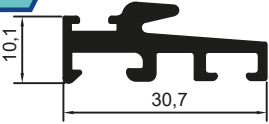

N-0314

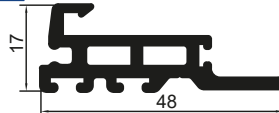

B-7782

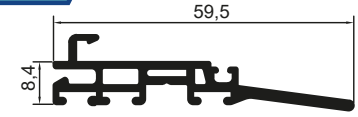

N-0272

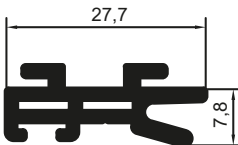

N-0134



N-0183

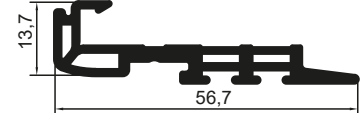

N-0164

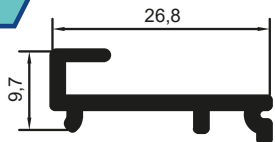

N-0184

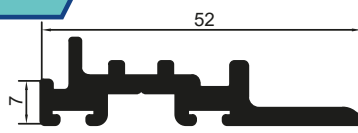

B-8069

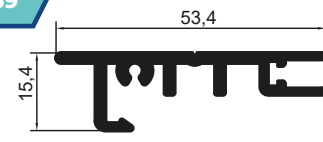

CLAMPING PROFILES KENET PROFİLLERİ

N-0282

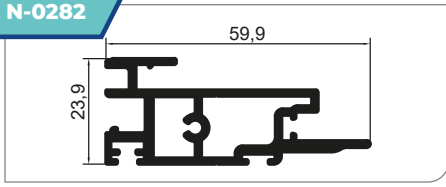

N-0448

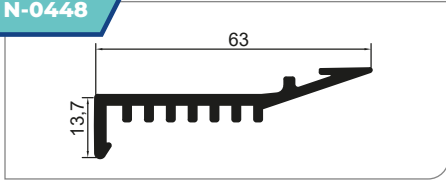

B-5933

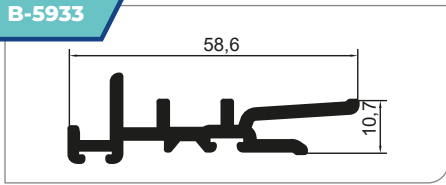

B-9686



N-0447

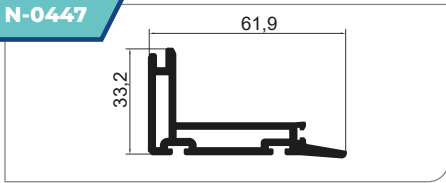

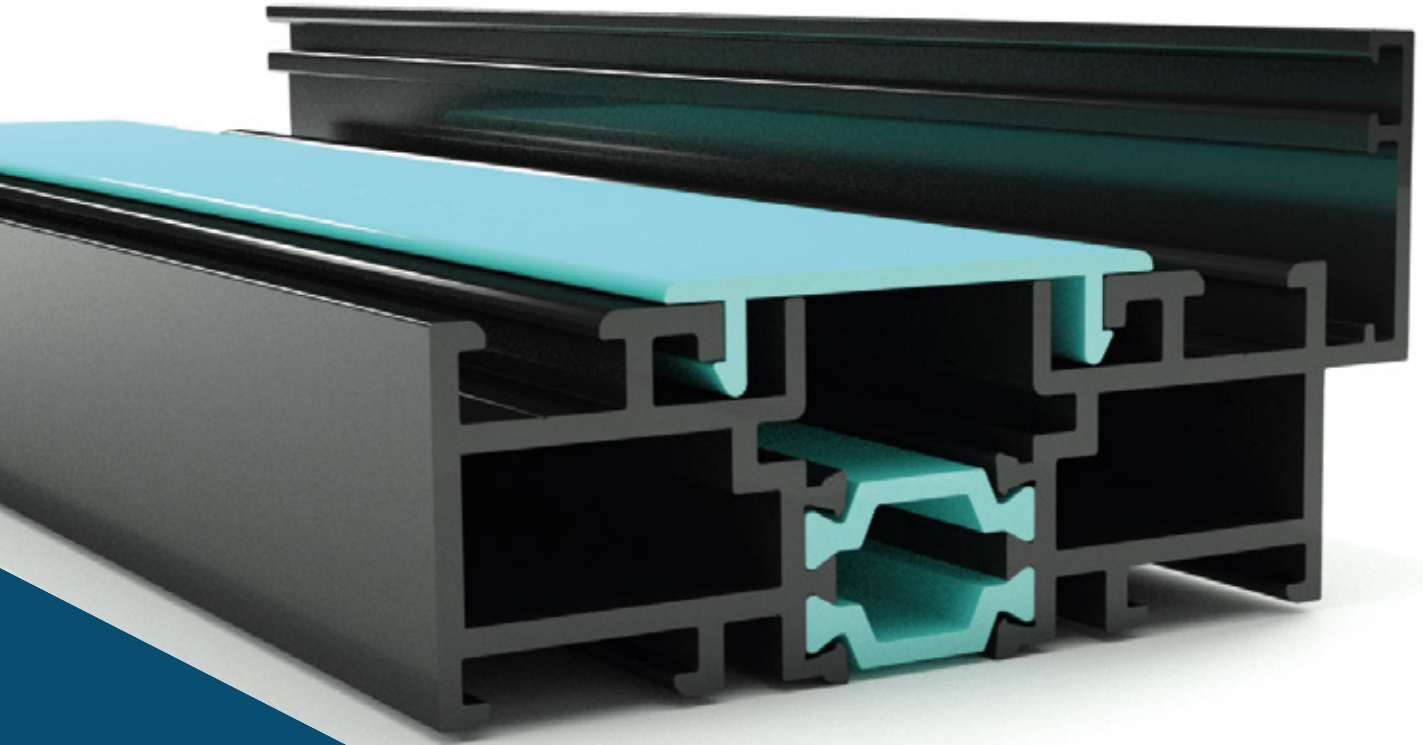

Nurmag Plastik

**SYSTEM
PROFILES**

SİSTEM PROFİLLERİ

N-0344

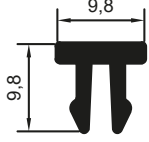

B-3627

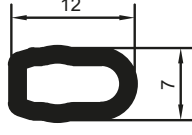

N-0438

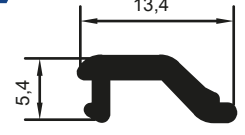

N-0292

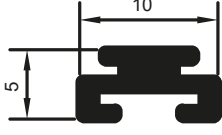

B-5693

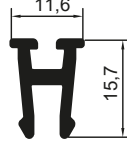

B-7780

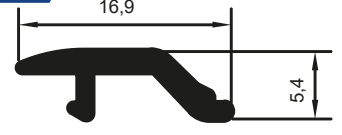

B-9558

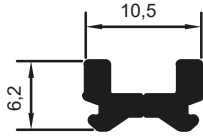

B-9157

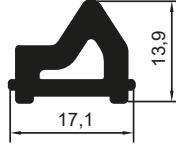

B-8665

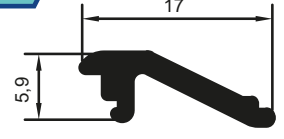

N-0357

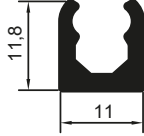

B-9831

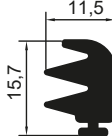

N-0488

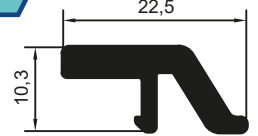

N-0345

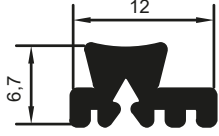

B-9832

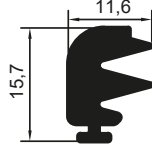

B-8666

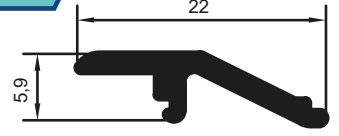

N-0482

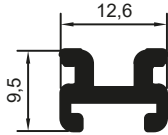

N-0416

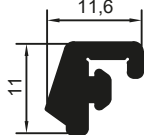

N-0320

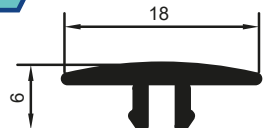

N-0273

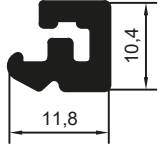

N-0297

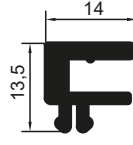

B-4063

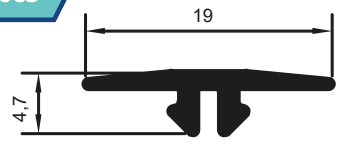

B-9156

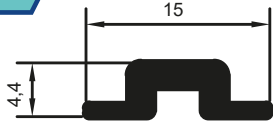

B-4726

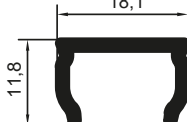

B-6914

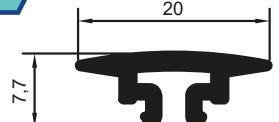

B-9234

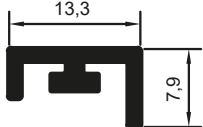

B-7140

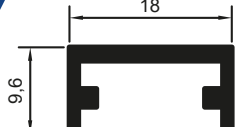

N-0239

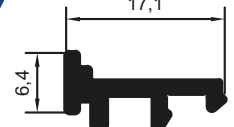

N-0111

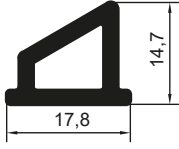

B-8330

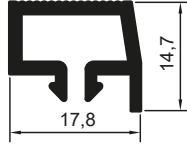

N-0402

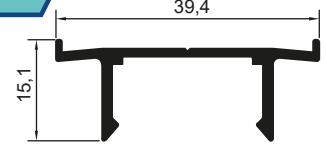

N-0415

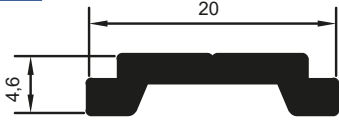

B-8331

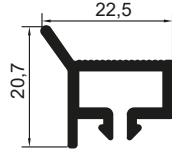

N-0240

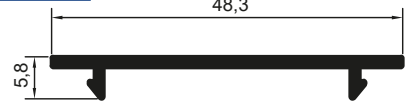

B-8804

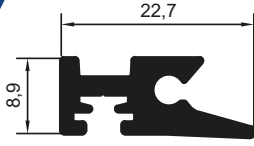

B-3178

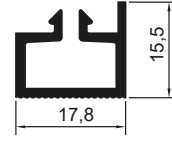

N-0208

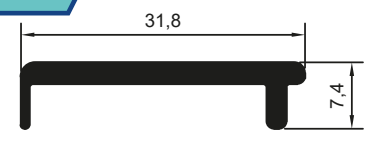

B-7956

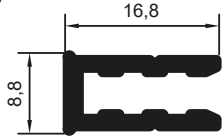

B-3177

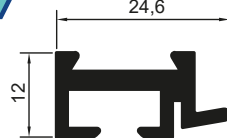

N-0208

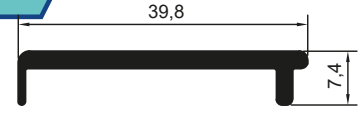

B-3320

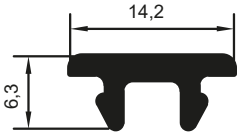

B-7208

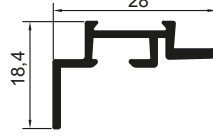

N-0210



B-5874

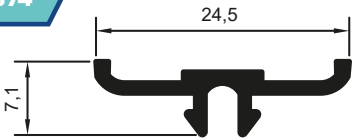

N-0341

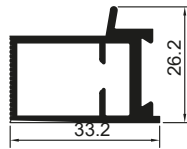

B-9319

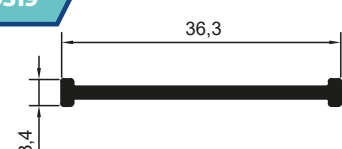

B-6908

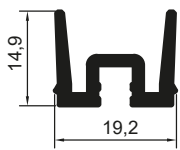

B-8667

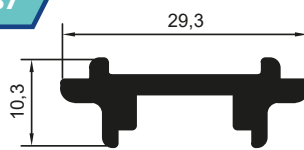

B-9321

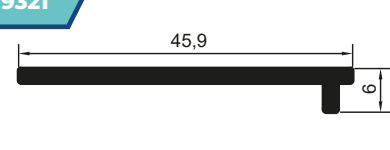

N-0322

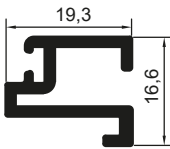

B-8667-1

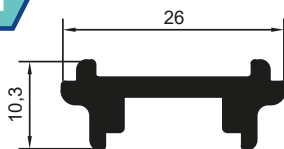

N-0306

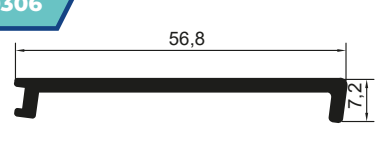

B-5860

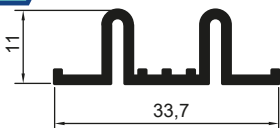

N-0358

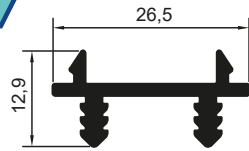

N-0342

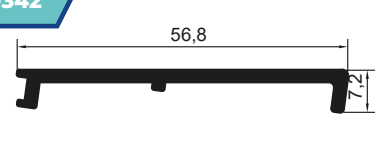

N-0437

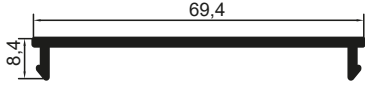

N-0289

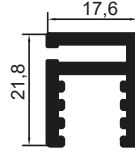

B-9919

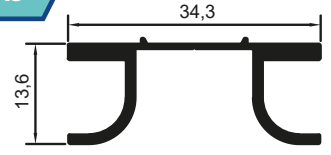

N-0379

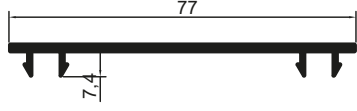

N-0290

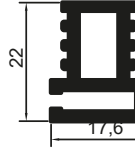

B-8560



B-9320

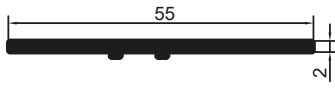

B-7207

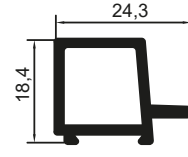

B-9281

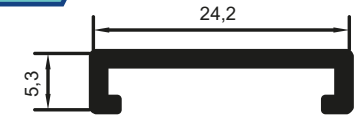

N-0288

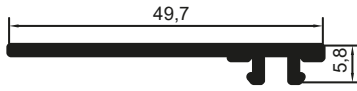

B-6473

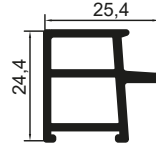

B-4062



N-0470

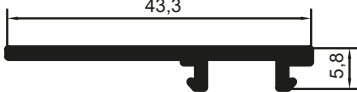

B-6920

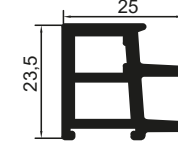

N-0473

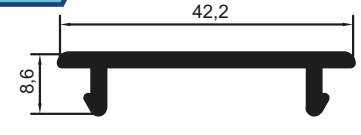

B-4744

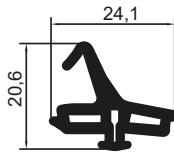

B-8255

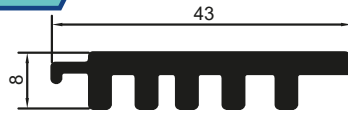

B-5475

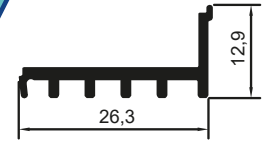

N-0018

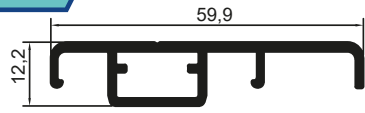

B-5982

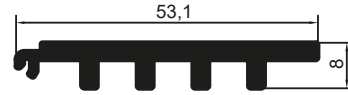

B-8801

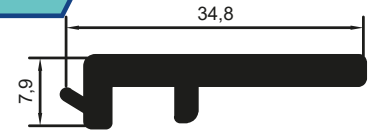

N-0276

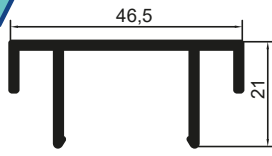

N-0241



B-6919

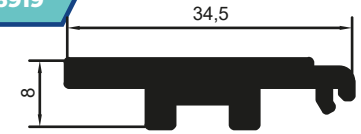

N-0062

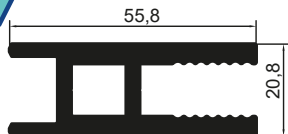

B-1021

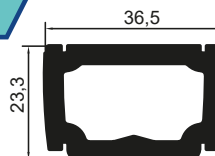

N-0474

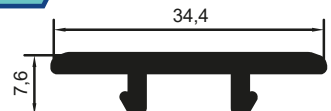

B-3689

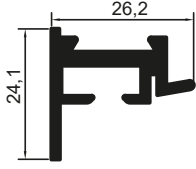

B-4270

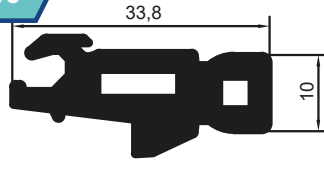

N-0158

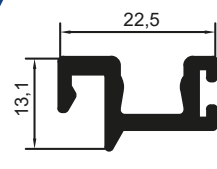

B-8332

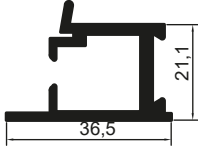

B-5833

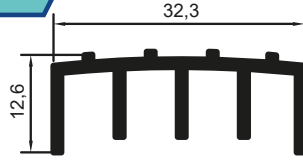

N-0442

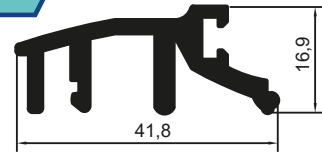

N-0110

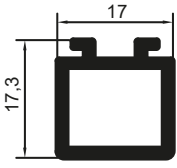

N-0108

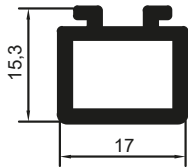

B-9322

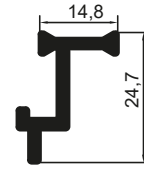

N-0109

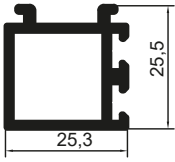

N-0429

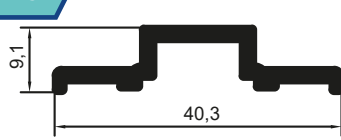

B-3323

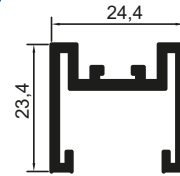

B-4269

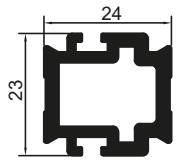

N-0333

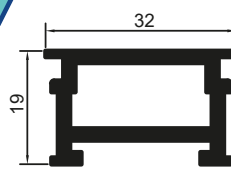

B-5862

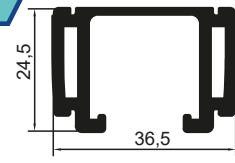

B-1020

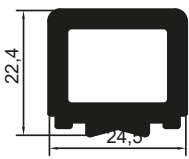

N-0112

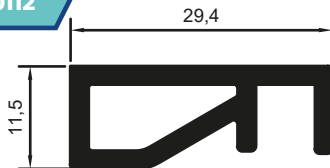

B-5257

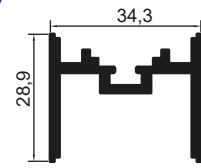

B-7630

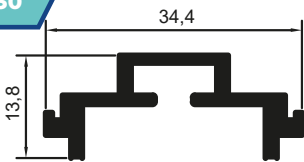

B-1037

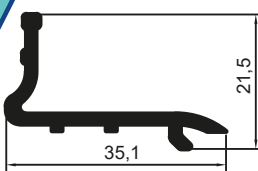

N-0116

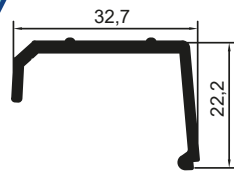

B-9248

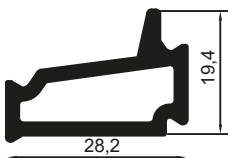

B-3311

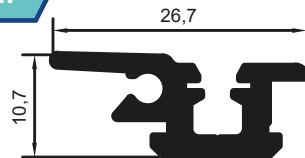

B-4232

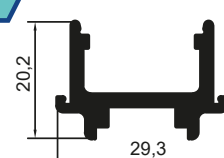

N-0061

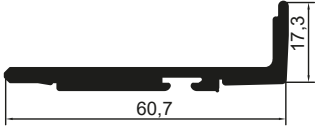

B-7206

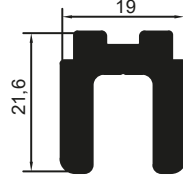

N-0102

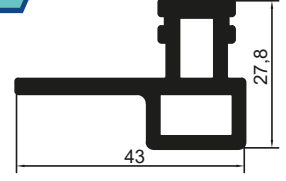

N-0060

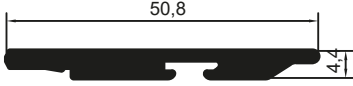

N-0115

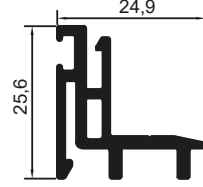

N-0103

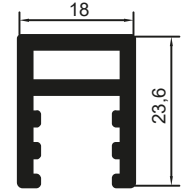

N-0422

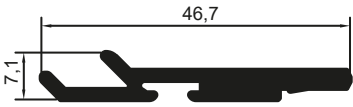

N-0121

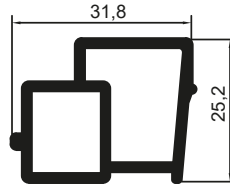

B-5949

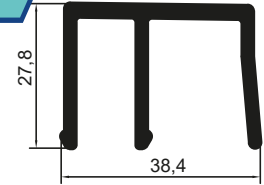

N-0421

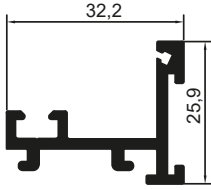

B-4648

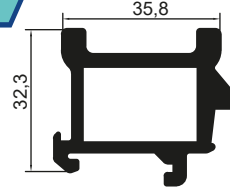

B-3625

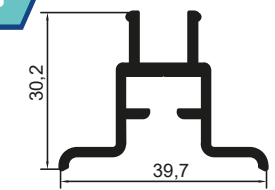

B-1378

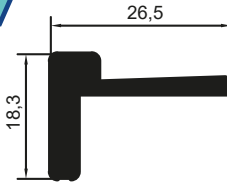

N-0407



N-0403

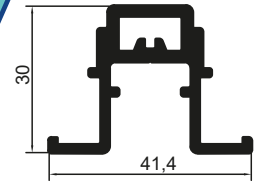

N-0275

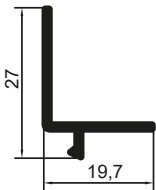

B-3324

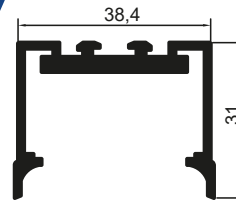

N-0344

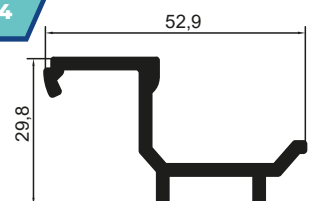

N-0037

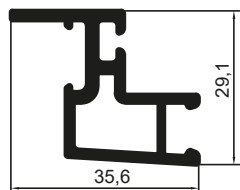

N-0316

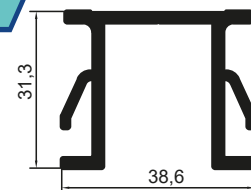

N-0219

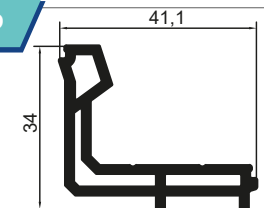

*FOR UNIQUE ALUMINIUM WINDOW,
DOOR & FACADE SYSTEMS*

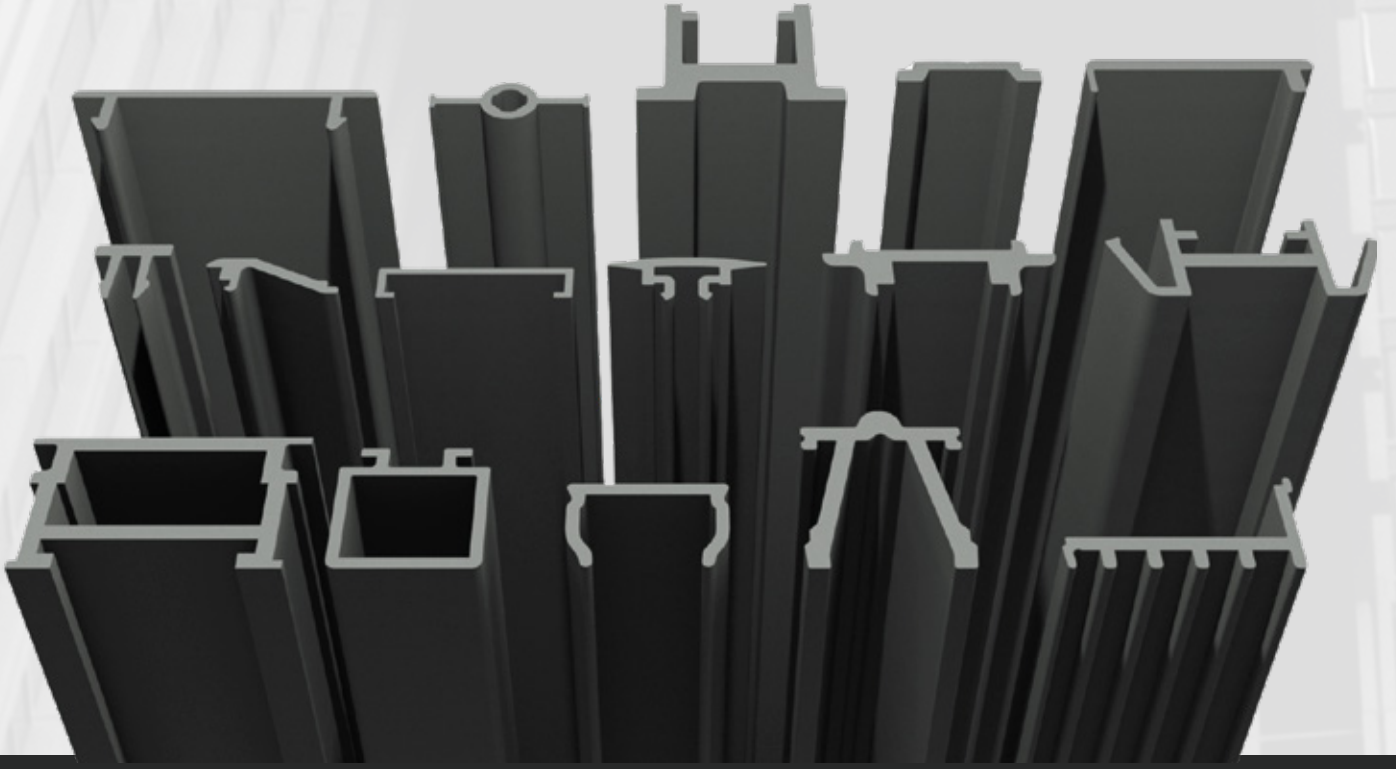

*BENZERSİZ ALÜMİNYUM KAPI, PENCERE &
DIŞ CEPHE SİSTEMLERİ İÇİN EN ÖZEL ÇÖZÜMLER*

✔ More Than 2000 Moulds
2000'in Üzerinde Ürün Çeşidi

✔ High Insulation Efficiency
Yüksek Yalıtım Performansı

✔ Just In Time Delivery
Tam Zamanında Teslimat

✔ Tailored Solutions For Unique Aluminium Systems
Alüminyum Sistemlere Özel Plastik Profil Tasarımı

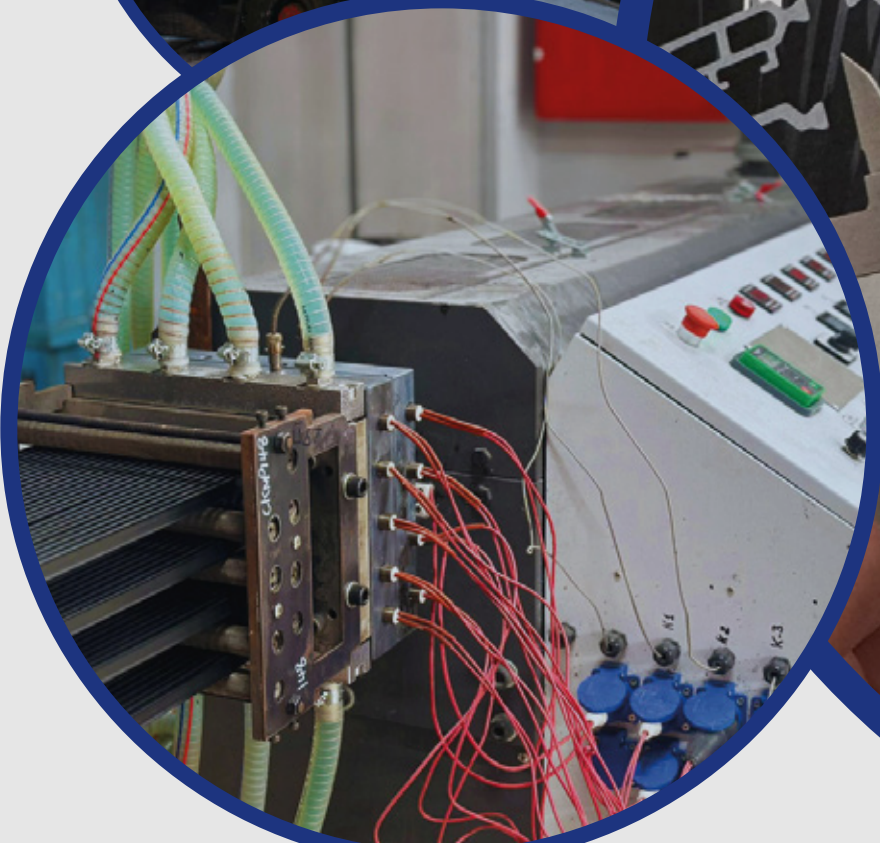





SOME PROFILES IN OUR CATALOGUE ARE FOR VISUAL PURPOSES ONLY.
SALES WILL NOT BE MADE TO A SECOND COMPANY OUTSIDE OF THE FIRMS WITH WHICH A CONTRACT HAS BEEN ESTABLISHED.
OUR COMPANY CANNOT BE HELD RESPONSIBLE FOR TYPOGRAPHICAL ERRORS.

KATALOĞUMUZDAKİ BAZI PROFİLLER ÖZEL PROFİL OLUP SADECE GÖRSEL AMAÇLIDIR.
SÖZLEŞME YAPILAN FİRMALAR DIŞINDA İKİNCİ BİR FİRMAYA SATIŞ YAPILMAZ.
TİPOGRAFİK HATALARDAN FİRMAMIZ SORUMLU TUTULAMAZ





“PVC & POLYAMIDE EXTRUSION PROFILES”



www.nurmagplastik.com.tr

info@nurmagplastik.com.tr

Nurmag Plastik

SANAYİ VE TİCARET LTD. ŞTİ.

 +90 (0216) 378 84 92 - 93

 +90 (0216) 378 84 96

 Sanayi Mah. Ensar Cad. Hidayet Sok. No:4
Kurtköy / Pendik / İstanbul

